

1

2

3

4

5

1

2

3

3

6

.....	1
.....	4
.....	7
.....	9
.....	12
SMT	15
SMT	20
.....	27
.....	30
.....	33
.....	36
.....	39

5.

1

6.

1

2

3

4

5

6

7

1

2

1

2

3

4

1

1

2

2

1

2

3

1

2

3

C 0.1 μ F

4

+

-

-

-

+

5

4

1

2

3

4

5
 1
 24V 35V
 2 /
 3
 220V
 15V
 1 200

6
 1
 Diode
 K PN A
 2-1

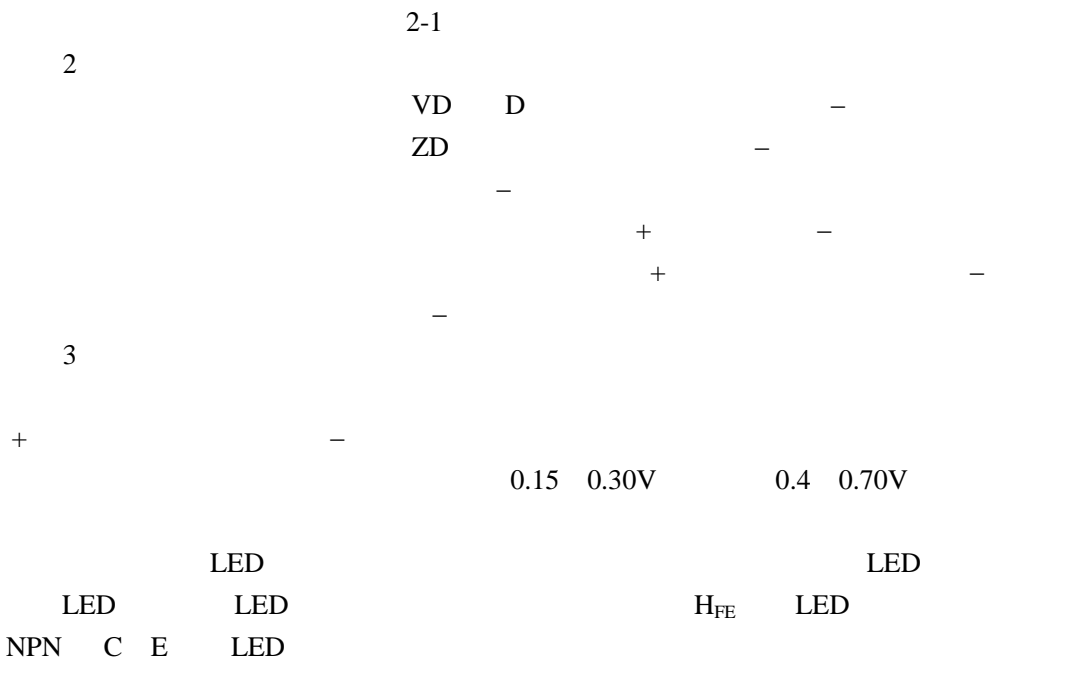
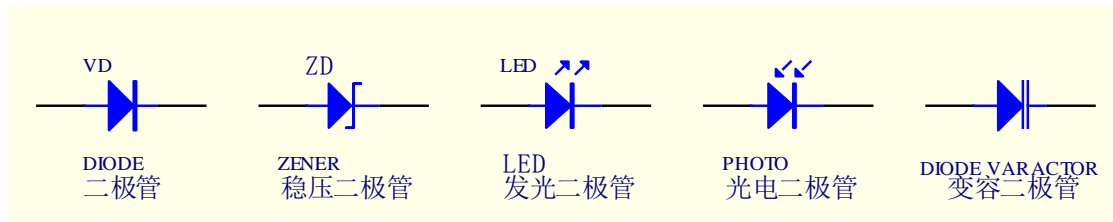

7
 1
 Transistor
 Junction Transistor BJT Bipolar

2-2

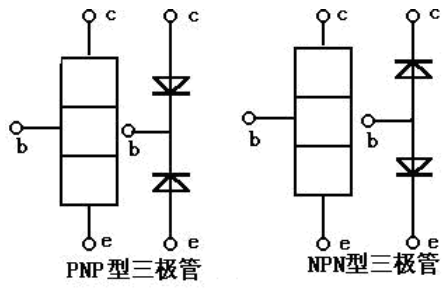

2-2

PNP

NPN

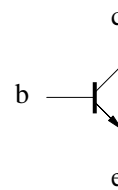
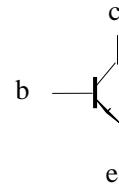

2

e b c

b

c

e b c

c

b

3

e

PN

b

c

NPN
1V

e

PNP

PN

0.2V

0.4V

PN

0.6V

h_{FE}

h_{FE}

8

1

- 1
- 2
- 3
- 4
- 5
- 6
- 7
- 8
- 11

6

6

3

3

6

2

6

3

6

3

1
2
3
4

1
2
3
4

1

2

20 50W

3

3-1 a

3-1 b

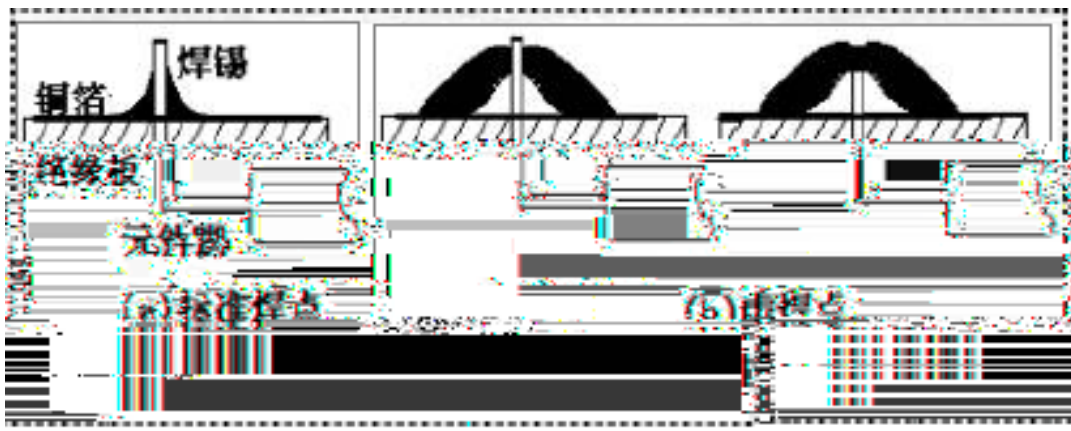

3-1

4

3-2

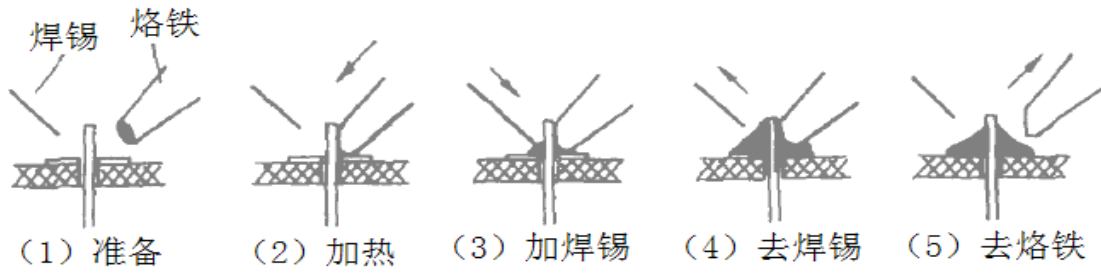

3-2

1

2

3

4

5

45°

5

1

2

3

4

5

6

1

2

3

4

5

6

1
2

1
2
3
4
5
6

1

1999 19999 199999

2

1
2

3

4

5

COM

6

PN

7

8

9

36V

25V

1000V

750V

36V

10

MPS-3000L

1
MPS-3000L 0 30V 0 3A

5V/3A

2
15 14
MPS-3000L
6 8 5
7
+5V 0 30V
5 7 6
8 6 8

3

1

DS5152CA
2 DS5152CA
150MHz
20
FFT

3 DS5152CA
1
2

10 10
1(CH1)
1 <CH1> <AUTO>

3
<AUTO> 1(CH1) 10

4

1

2

1
2
3
4

1
2
3
4
5

4-1

5-1

1	ChongDianQi			1
2	R1 R3		1k 1/8W	2
3	R2		1 1/8W	1
4	R4		33 1/8W	1
5	R5		270 1/8W	1
6	R6		220 1/8W	1
7	R7 R9		24 1/8W	2
8	R8 R10		560 1/8W	2
9	Rp1		1k	1
10	C1		470μF/16V	1
11	C2		22μF/10V	1
12	C3		100μF/10V	1
13	VD1 VD7		1N4001	7
14	LED1 LED2 LED-A		3	3
15	LED-P		3	1
16	VT1		8050 NPN	1
17	VT2 VT3		9013 NPN	2
18	VT4 VT5		8550 PNP	2
19	T		3W 9V	1
20	L1			1
21	S4 S5			

	CH2 GND			
24	S1 S2 S3 S4 S5			3

		220V		3 9V
		1 4		
1				
1	AC	220V		
			3V 6V	±10%
2			300mA	
3				
4		60mA ±10%	1 4	10 12
2				
	5-1			

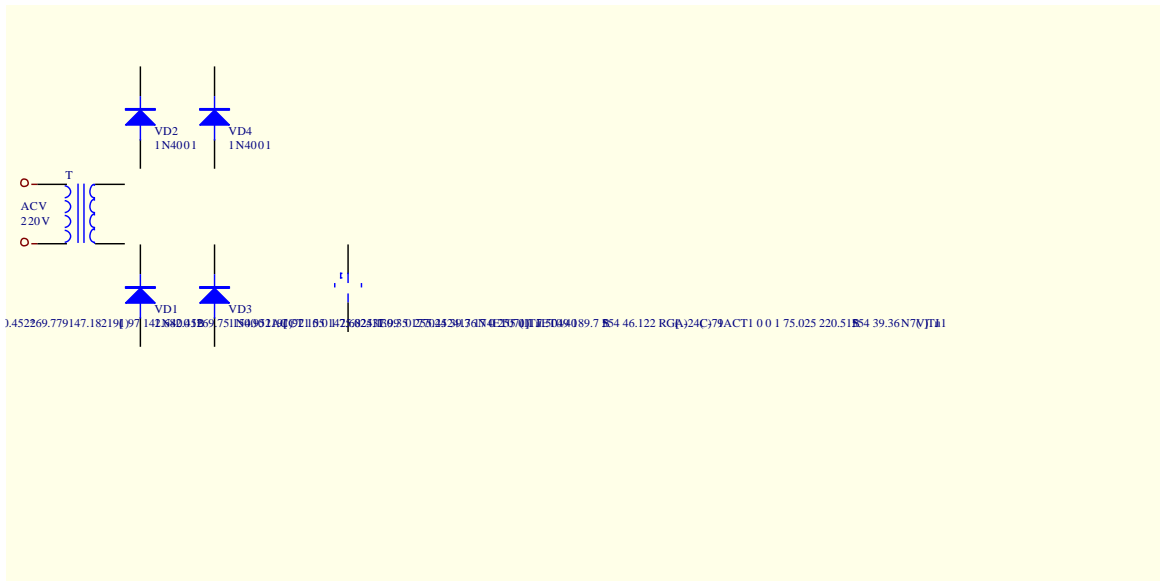

	5-1				
	5-1	T	VD1 VD4	C1	
	R1	LED-A			
LED-P					
	1.9V				LED
			R2 LED-A		LED-A
			R2		LED-A
		VT1 VT2			
	S1 S2 S3		3V 6V	S4	S4
S5		S4 S5	+	S4 S5	
-					

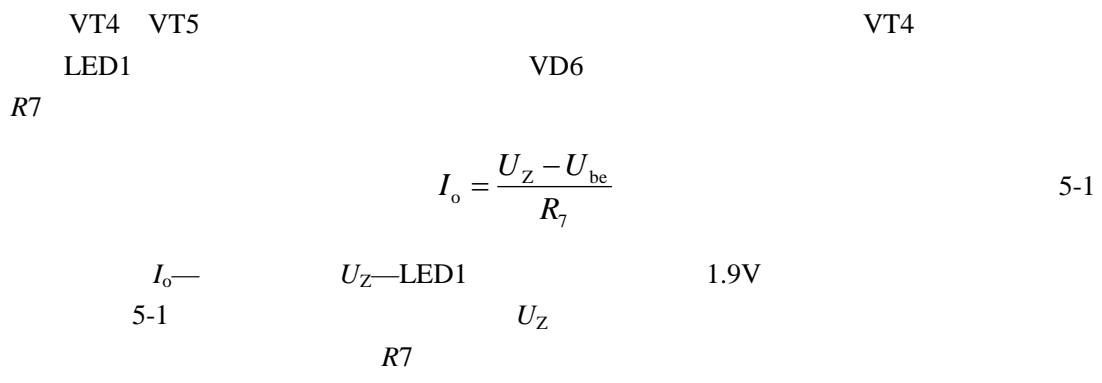

- 1
- 2
- 3.
- 4.
- 5.

- 1
- 2.
3. 5-1

- 4
- 5.

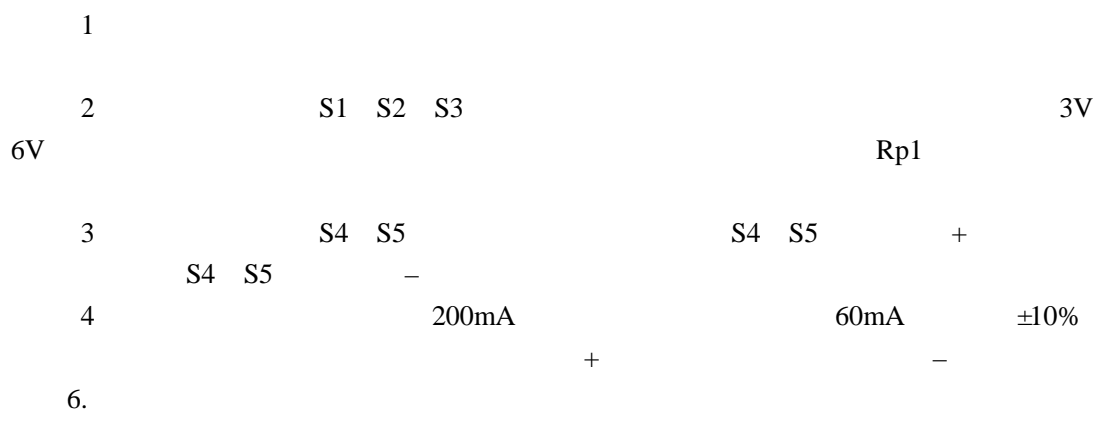

SMT

1 SMT

2 SMT SMT
 3 SMT
 4 SMT

1 SMT
 2
 3
 4
 5

1 SMT

20 70 80
 Surface Mounting Technology SMT PCB
 SMT Through Hole
 Technology THT SMT 90% SMT

2. THT SMT
 6-1 THT SMT

6-1 THT SMT

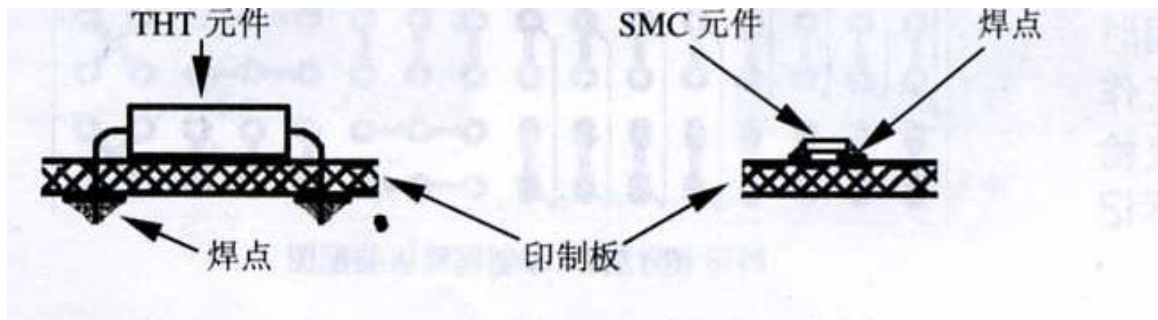

6-1 THT SMT

6-1 THT SMT

	20 60 70	THT		PCB	/	

	70 80		IC	PCB		
	20 80	SMT	SMC SMD VSI VLSI	SMB		

3. SMT

1 SMC SMD 1/3 1/10 PCB
SMT

40% 60% 60% 80%

2 SMC SMD

THT

3 SM

4 SMT CIMS

5 SMT PCB SMD,SMC

SMT 30%

4. SMT

SMT

THT

SMT

SMT

SMT

SMD Surface Mounting Devices

1

6-2

6-2

\

1005/*0402 1608/*0603 2012/*0805 3216/*1206 3225/*1210 4532/*1812 5664/*2225

0.9 4.0

NPO
X7R
Y5V

2

FET/

SOP(Small Outline

Package) TO SC-70(2.0×1.25) SO-8(5.0×4.4)

SOP QFP(Quad Flat Package) 6-2 6-3

SMD BGA

6-4 BGA

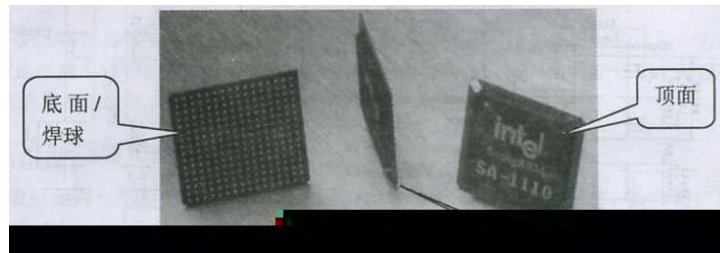
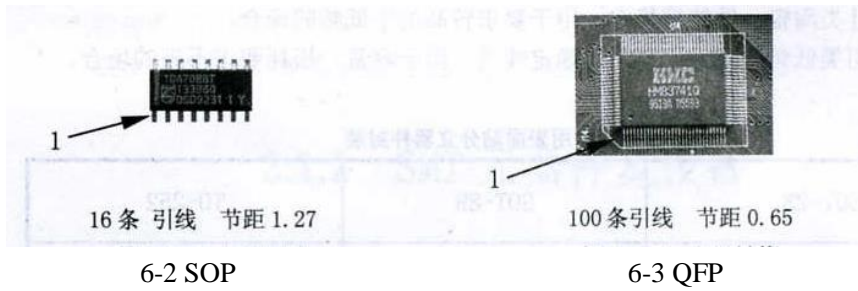

6-4 BGA

5. SMT

SMT

1

6-5

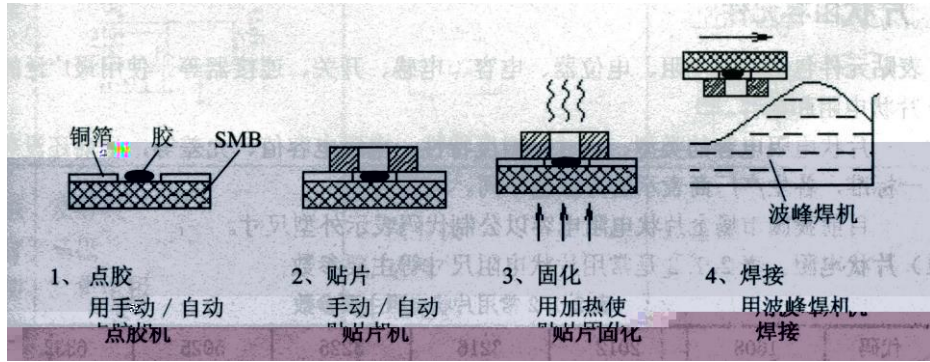

6-5 SMT 1

2

6-6

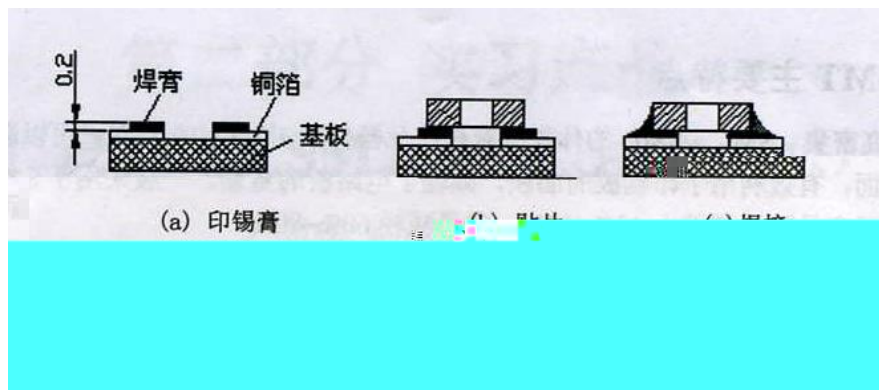

6-6 SMT 2

6.

1

2

6

7.

1

- 1 SMT
- 2 SMT
- 3 SMT

- 1 SMT
- 2 SMT FM
- 3
- 4
- 5

SMT FM

- 1. FM

FM

87 108MHz,

1.8 3.5V

1.2V

1.5V

- 2. FM

- 1 FM

7-1

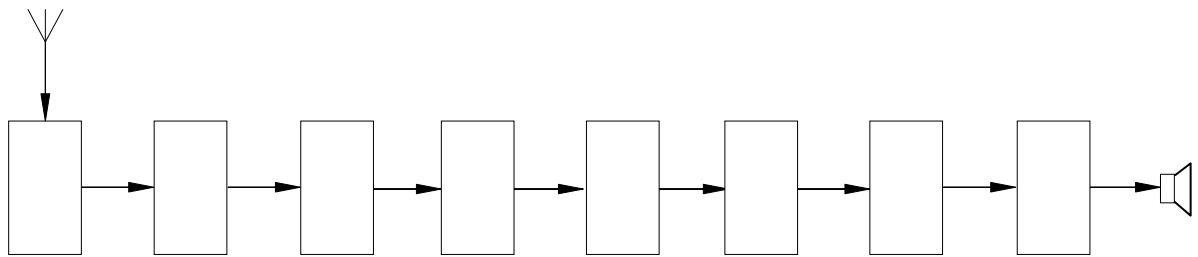

7-1

- 2 FM

7-2

FM

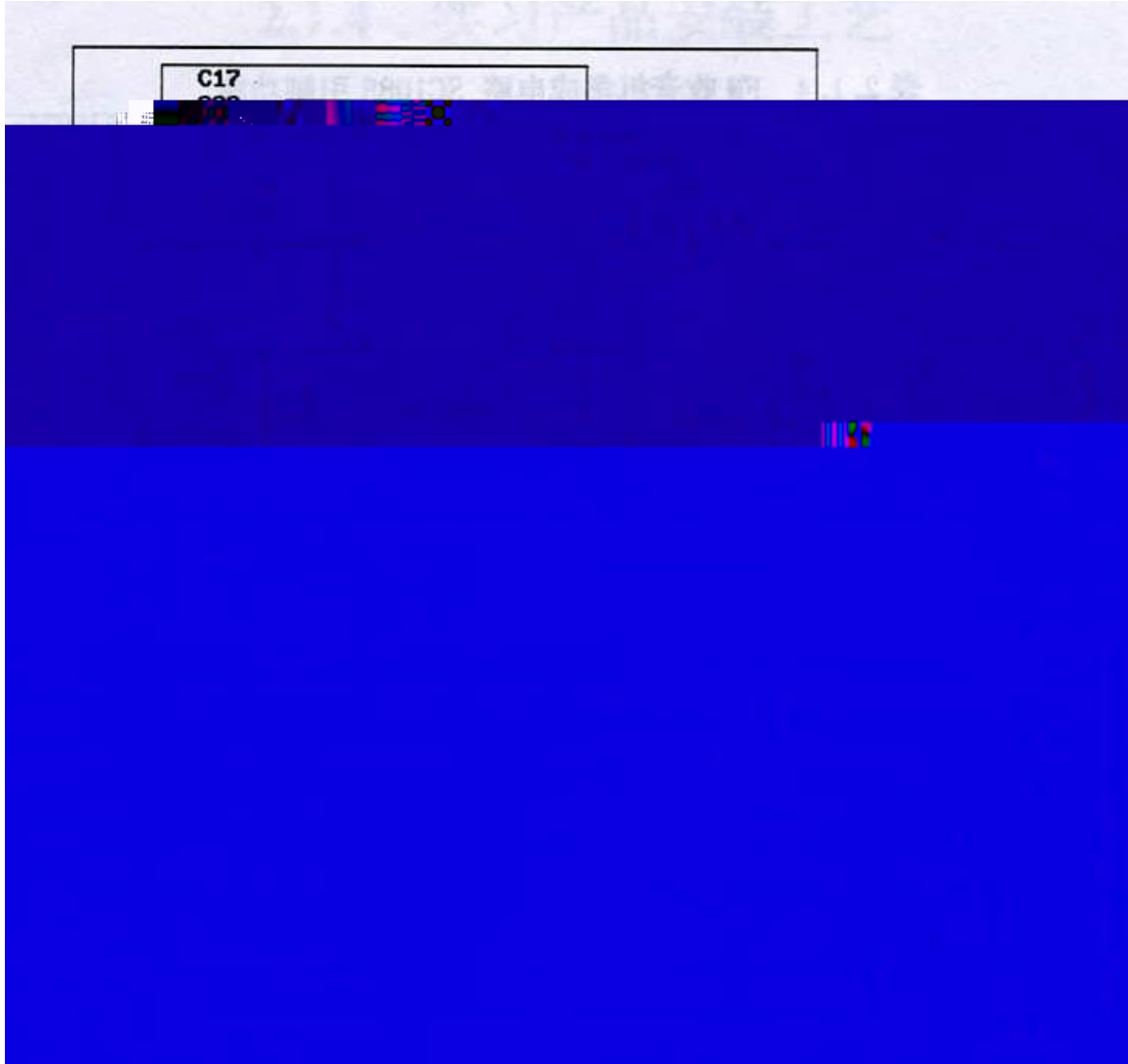

7-2 FM

3.

SC1088

70KHz

SC1088

SOT16

8-2 FM

1 FM

C14 C13 C15 L1

IC 11

12

FM

2

PN

Ud Cd Ud

V1 IC 16

S1 IC

RS 16 C9 C9 V1

V1 C8 L4

IC RS C9

AFC(Automatic

Frequency Control)

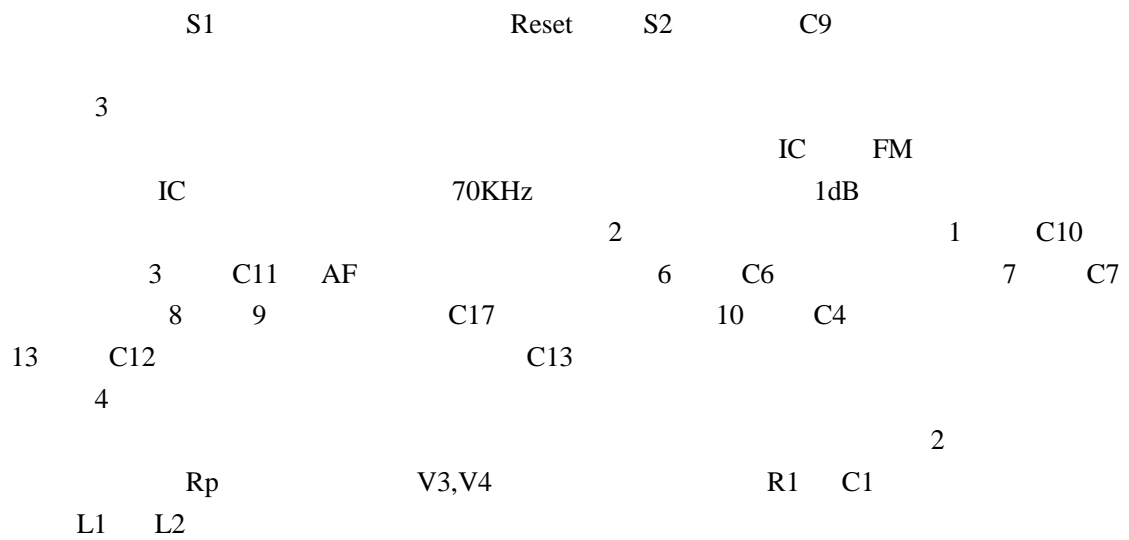

4. SC1088
 7-1 FM SC1088

7-1 FM			SC1088				
1		5		9	IF	13	
2		6	IF	10	IF	14	
3	AF	7	1dB	11		15	
4	Vcc	8	IF	12		16	AFC

SMT

7-3 SMT

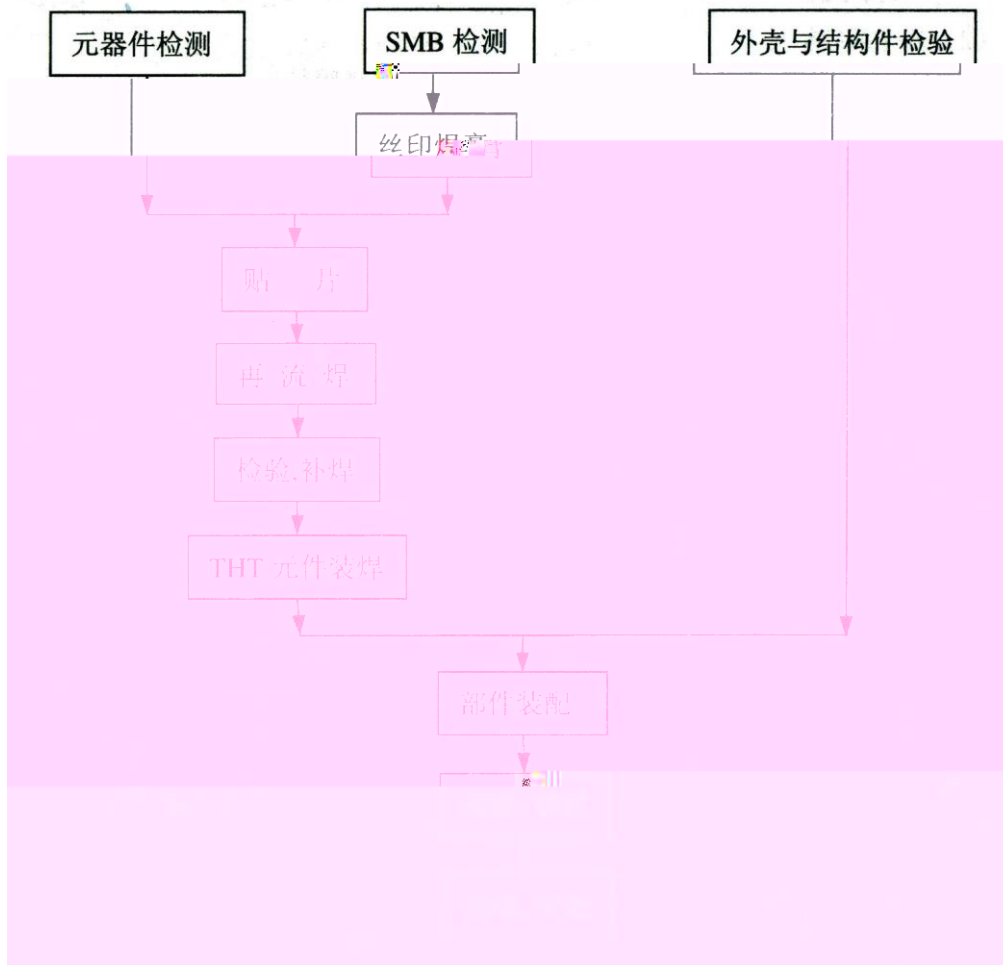

7-3 SMT

SMB

THT

SMC

SMD

SMT

SMT FM

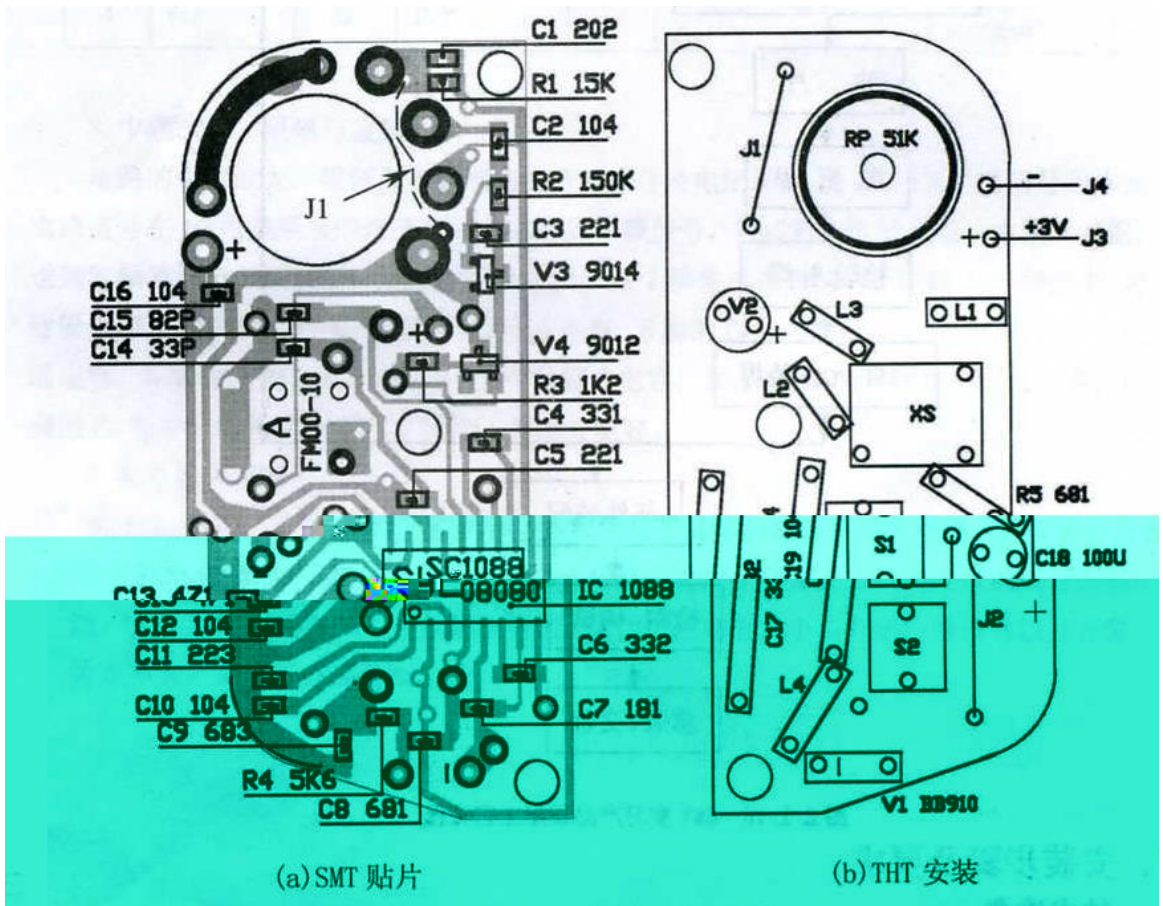

(a) SMT 贴片

(b) THT 安装

7-4 SMT FM

1 SMB

-
-

3
4
5
4.
5.
1

THT

2

200mA

50mA
7 30mA

LED

V	1.8	2	2.5	3	3.2
mA	8	11	17	24	28

35mA

3

S1

4

87 108MHz
87.6MHz L4
SC1088

Reset FM Scan

FM
5

FM

97.4MHz

L4

6.
1

L49

2

SMD/

SCAN
SMB
LED

RESET

7.

- 1
- 2
- 3
- 4

- 1 SMT FM
2. SMT
- 3.
- 4
- 5
- 6
- 7
- 8.

1
2
3 TDA2822M D2822
4
5
6

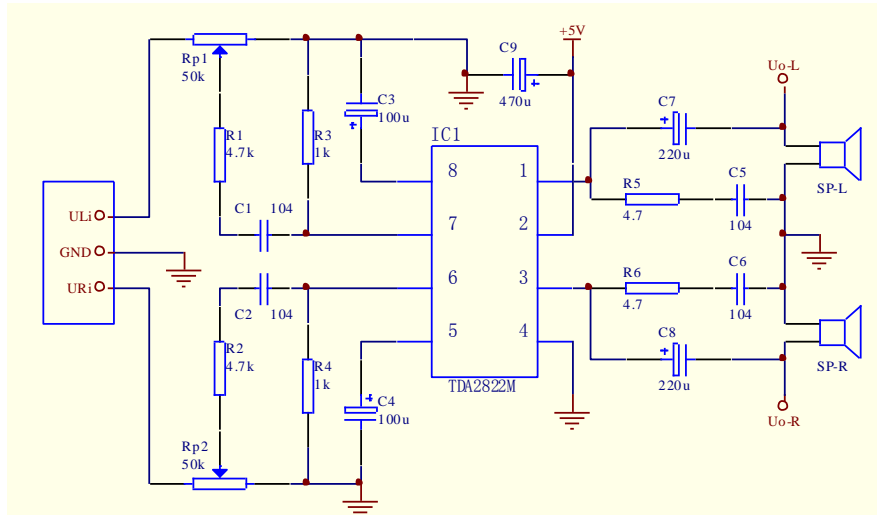

8-1

- 1
- 2
- 3.
- 4.

- 1
- 2.
- 3.

- 5
- 6.
- 7.

1
2

3
5

1

4
6

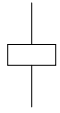

KM

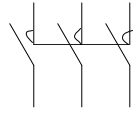

KM



KM

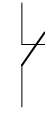

KM

6

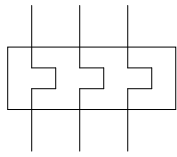

7

0.4 80s

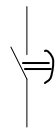
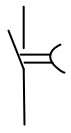
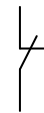
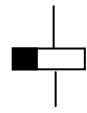
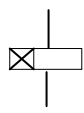
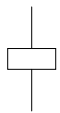

8

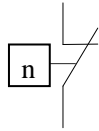
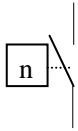

9

10

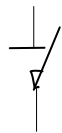

1

2

3

1
2
3

1	1	2	3
3	1	4	1
5	1	6	1
7	1	8	1
9	1	10	
11		+ /-	1

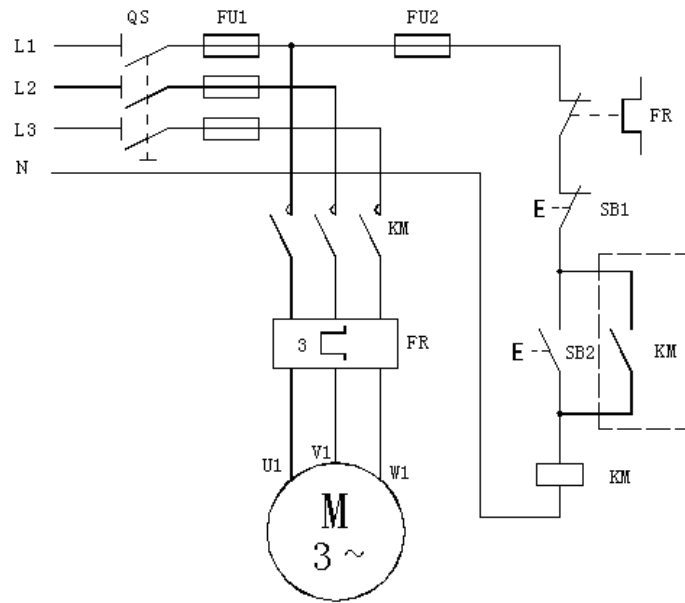

1

		L ₁	L ₂	L ₃		QS		FU ₁
					FR			
		KM						
		FU ₂			KM		SB ₂	SB ₁
FR								
					KM			
2								
1					KM			
		SB ₂ →			KM	→	KM	M
		SB ₂ →			KM	→	KM	M
2							KM	SB ₂

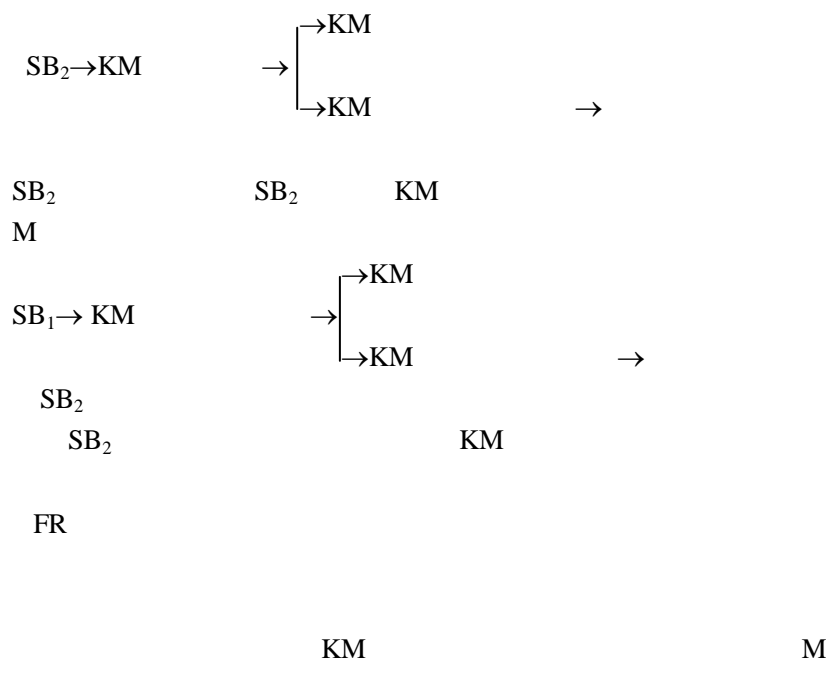

1

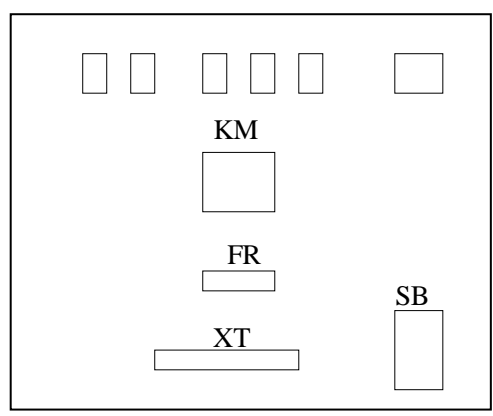

10-2

4

1

2
90°

3-4

3

4

5

70%

3

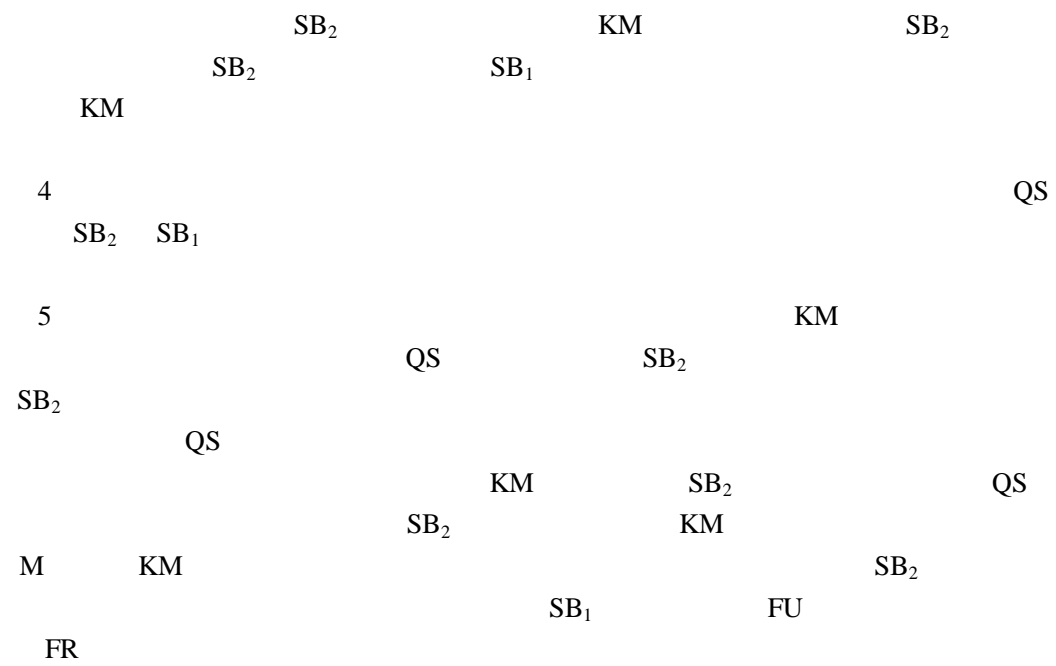

1
2
3

1	1	2	3
3	1	4	2
5	1	6	1
7	1	8	1
9	1	10	
11		KM+ /-	1

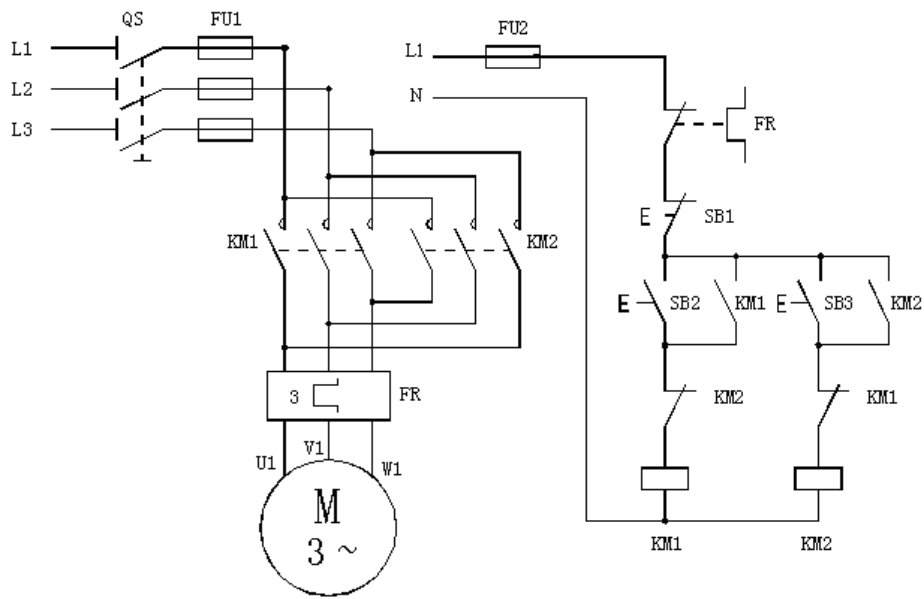

KM₁ KM₂ KM₁ KM₂ KM₁

L₁ L₂ L₃

KM₂

L₁ L₃ L BT1 0 0 1 89.904 190.58 Tm 148>> BDC BT/F4 10.56 Tf</M20.13 190.58 Tm{02C9>JTJET1

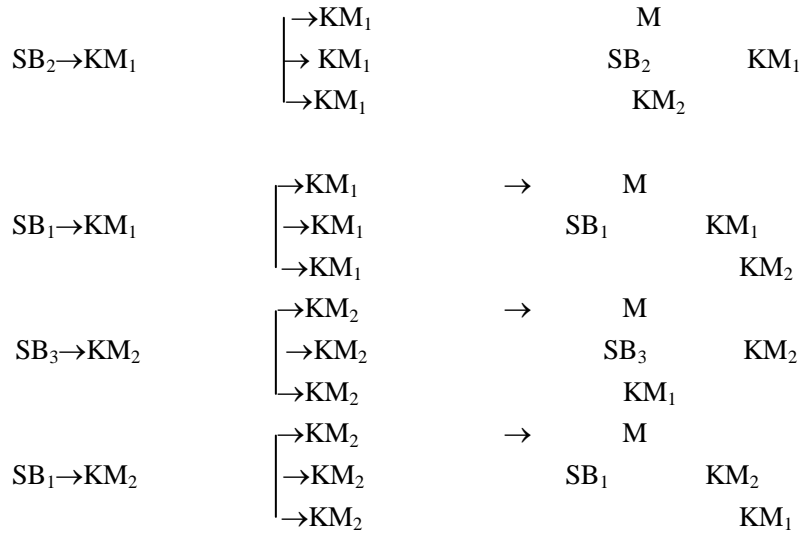

- 1
- 2
- 3

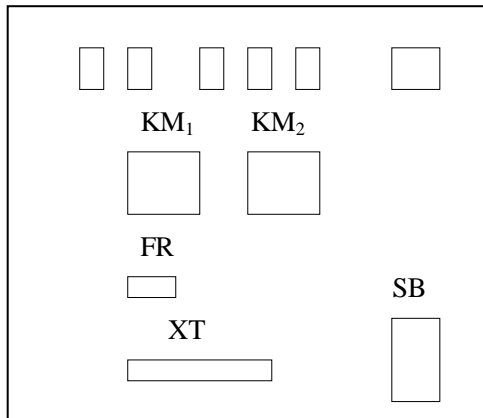

- 4
- 5
- 1
- 2
- 3

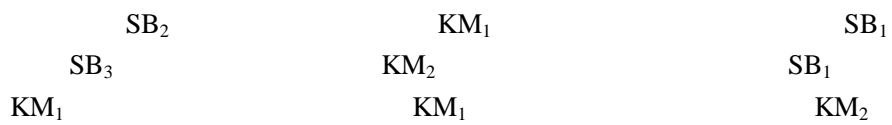

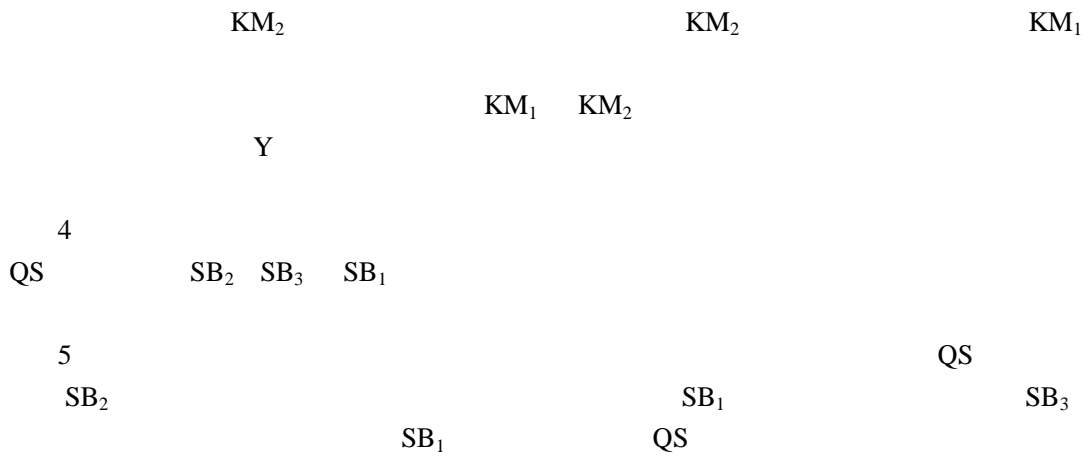

- 1 Y
- 2 Y
- 3

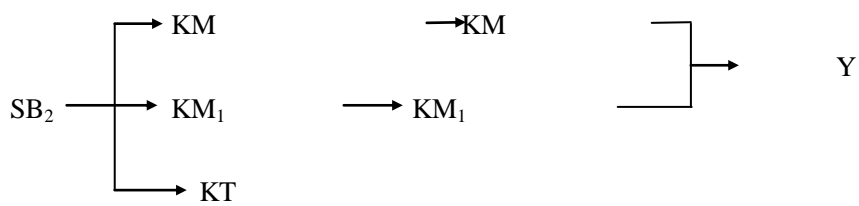
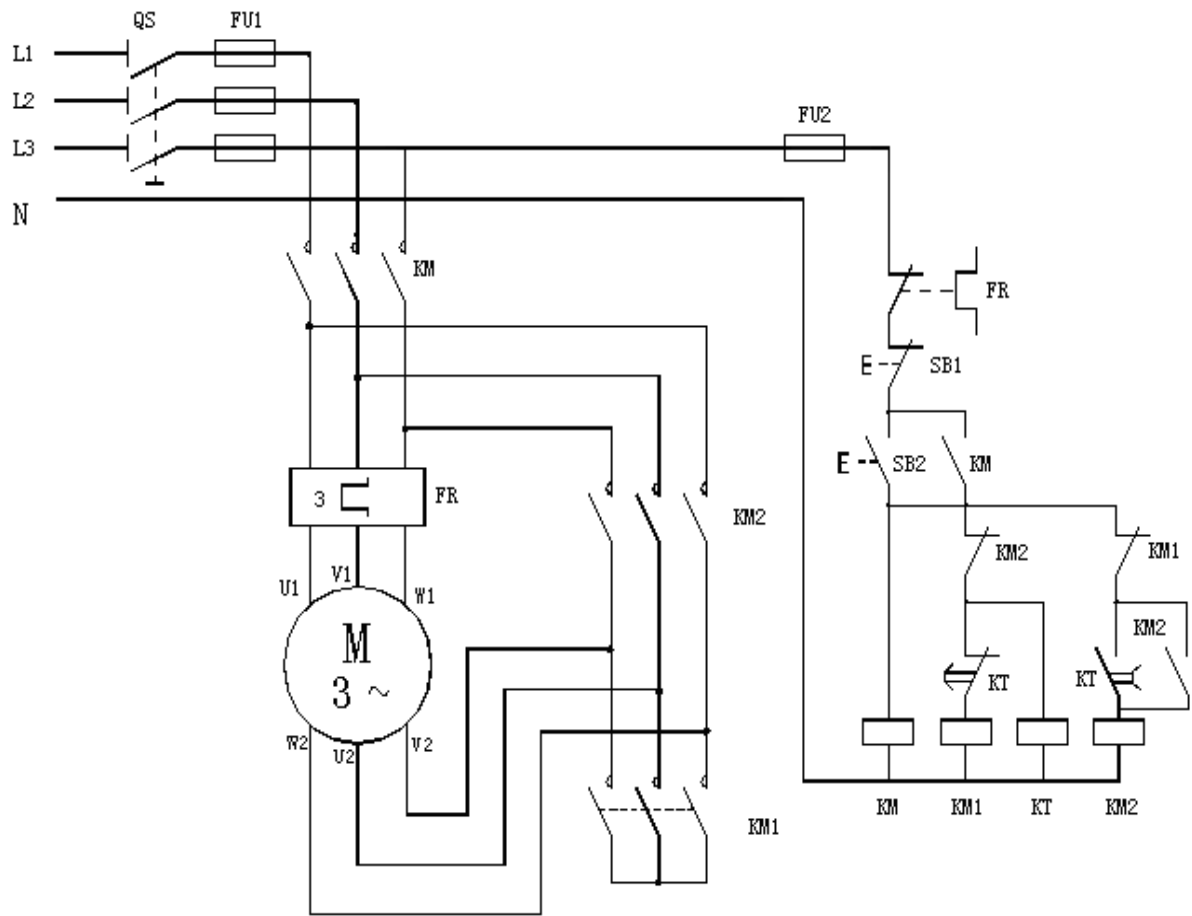

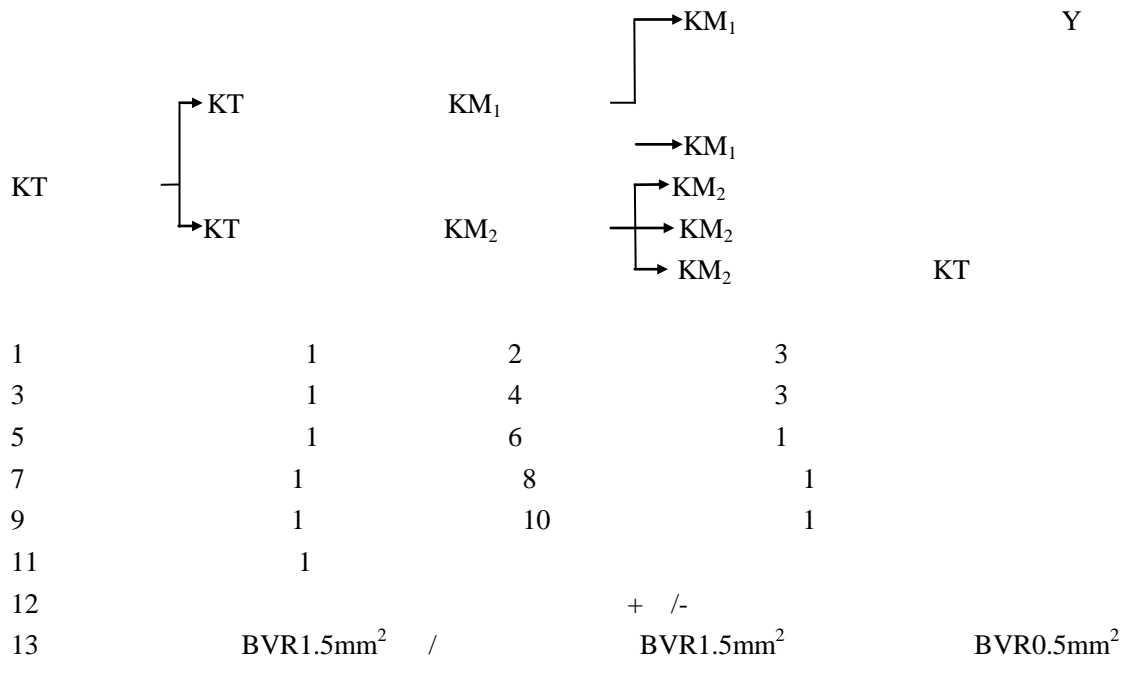

- 1
- 2
- 3

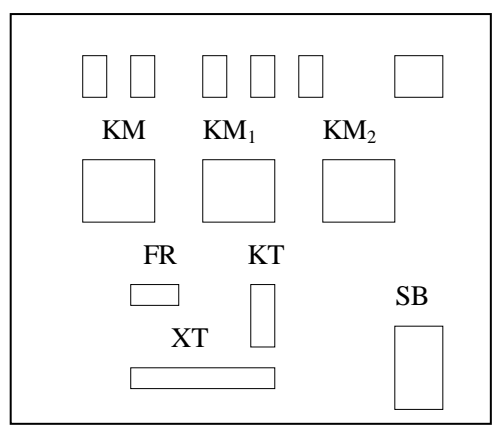

- 4
- 5
- 1
- 2
- 3

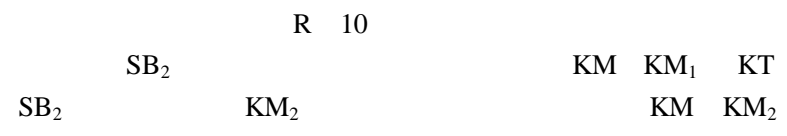

			SB ₁							
				KM ₁	KM ₂					
Y										
4										QS
	SB ₂	KM	KM ₁	KT	KM ₂			SB ₁		
5										
									QS	SB ₂
							Y-			
SB ₁									KM ₂	KM ₃
										QS